

MANDÍK CPV48-H



MANDÍK®

MANDÍK CPV48-H



Nominal air power:	4800 [m ³ /h]
Input power:	3~400 V / 50 Hz – water heat / condenser
	3~400 V / 50 Hz – electric heat
The maximum operating current:	5,5 [A] – water heat / condenser
	43.2 / 49.2 / 57.2 [A]* – electric heat
External surface finish:	RAL 9010 + RAL 5012 (standard version)
Internal surface finish:	RAL 9010 (standard version)
Weight:	350 [kg]
Sheathing insulation:	mineral wool, 65 kg/m ³

* power grades of electric heat

Levels of acoustic performance:

Frequency band	LwA [dB]	63	125	250	500	1000	2000	4000	8000	[Hz]
Suction inlet	76.9	67.3	72.42	78.54	74.46	69.36	69.36	65.28	62.22	[dB]
Discharge inlet	83.7	72.4	74.46	81.6	79.56	79.56	76.5	71.4	67.32	[dB]
Suction outlet	76.4	67.3	74.46	78.54	74.46	68.34	68.34	64.26	61.2	[dB]
Discharge outlet	82.8	71.4	75.48	81.6	78.54	78.54	75.48	70.38	67.32	[dB]
Noise to the ambient	62.5		48.2	59.7	55.2	55.1	50.3	42	31	[dB]

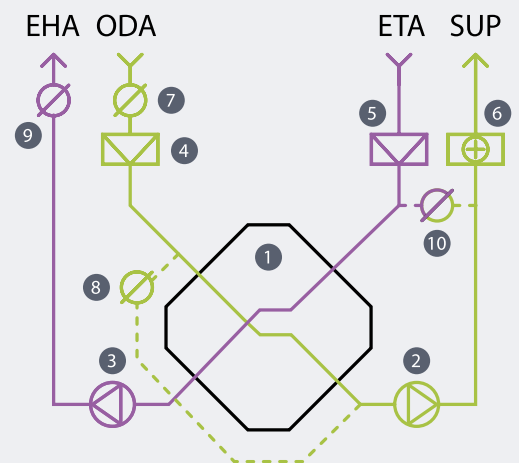
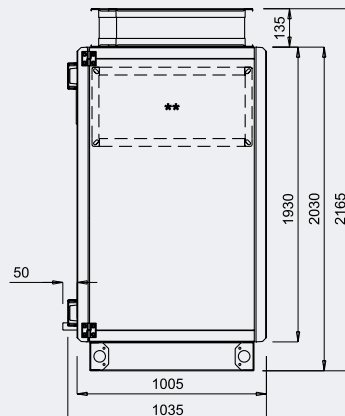
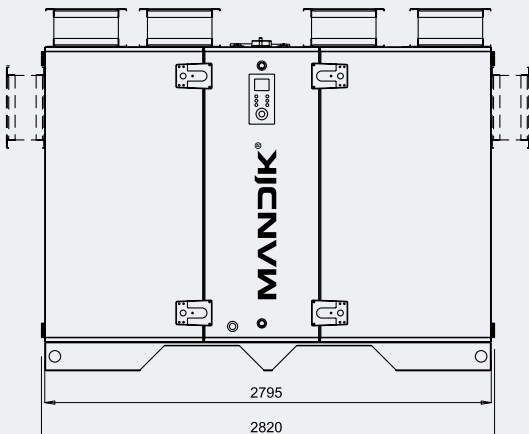
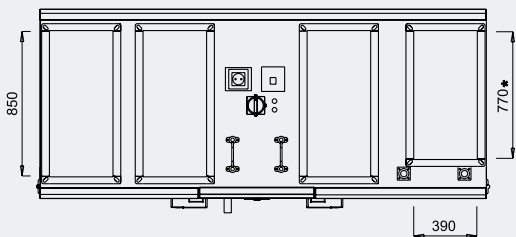

ODA – fresh air
SUP – outlet air EHA

ETA – inlet air
EHA – waste air

- 1 Board recuperator
- 2 Inlet ventilator
- 3 Outlet ventilator
- 4 Inlet filter
- 5 Outlet filter
- 6 Post heat
- 7 Inlet flap
- 8 By-pass flap
- 9 Outlet flap
- 10 Mixing flap

* for water heat / condenser; for electric heat = 850 mm

** possible SUP/EHA outlets to lateral sides, size 850 × 390 mm

Filtration

Přivod:	F7, compact, 525 × 915 × 96 mm
Odvod:	M5, compact, 525 × 915 × 96 mm

Recuperation

Cross-shaped exchanger (board type, counter-flow)	
Temperature efficiency in the winter:	74.4 [%] *
Temperature efficiency in the summer:	77.7 [%] **

* in the conditions according to EN 308, ODA = 5 °C / 20 % rH, ETA = 25 °C / 20 % rH

** in the conditions according to ODA = 32 °C / 45 % rH, ETA = 25 °C / 50 % rH

Mixing

Possible installation of the flap intended for mixing the outlet condition of the air with the fresh air, including possibility to set up the minimum and maximum rate of mixing.

Post heating

Water re-heat CPV48

Power	STANDARD				INCREASED				HIGH			
Q_t, t_{sup}	24.8 kW, $t_{sup} = +22\text{ °C}$				29.1 kW, $t_{sup} = +25\text{ °C}$				33.9 kW, $t_{sup} = +28\text{ °C}$			
medium – water	80/60 °C	70/50 °C	50/40 °C	45/35 °C	80/60 °C	70/50 °C	50/40 °C	45/35 °C	80/60 °C	70/50 °C	50/40 °C	45/35 °C
Number of rows	2	2	2	3	2	2	3	3	2	2	3	4
flow of medium [m ³ /h]	1.09	1.09	2.16	2.15	1.28	1.27	2.53	2.52	1.49	1.49	2.95	2.95
pressure loss of medium [kPa]	6.4	6.6	24.1	6.4	8.6	8.8	8.5	8.5	11.4	11.6	17	8.4
Connections	DN 20	DN 20	DN 20	DN 25	DN 20	DN 20	DN 25	DN 25	DN 20	DN 20	DN 20	DN 25

material of the tube / lamella Cu/Al

Electric re-heat CPV48

Power	STANDARD				INCREASED				HIGH			
Q_t, t_{sup}	24.8 kW, $t_{sup} = +22\text{ °C}$				29.1 kW, $t_{sup} = +25\text{ °C}$				33.9 kW, $t_{sup} = +28\text{ °C}$			
Heating spirals	13 × 2.0 kW				15 × 2.0 kW				17 × 2.0 kW			
Current [A]	38				44				52			

The heater is equipped with operating (+50 °C) and emergency (+80 °C) thermostat

Condenser CPV48

Power	STANDARD				INCREASED				HIGH			
Q_t, t_{sup}	24.8 kW, $t_{sup} = +22\text{ °C}$				29.1 kW, $t_{sup} = +25\text{ °C}$				33.9 kW, $t_{sup} = +28\text{ °C}$			
Cooling agent	R410A		R407C		R410A		R407C		R410A		R407C	
Number of rows	3		3		3		3		4		4	
flow of medium [m ³ /h]	4.2		6.4		4.2		6.5		5.5		8.4	
Volume [l]	4		4		4		4		5.3		5.3	
Connections in/out	1 × 28 / 1 × 22		1 × 28 / 1 × 22		1 × 28 / 1 × 22		1 × 28 / 1 × 22		1 × 28 / 1 × 22		1 × 28 / 1 × 22	

With condensing temperature = 50 °C, one-way direction – heating only, one-circuit, material of the tube / lamella Cu/Al

EC ventilators (inlet / outlet)

Input power:	1.574/1.3 [kW]*
Voltage:	400 [V]
Current:	2.6/2.39 [A]
RPM	2117/2052 [RPM]

* in case of external pressure loss 250 Pa, air performance 4800 m³/h, water heat – standard performance

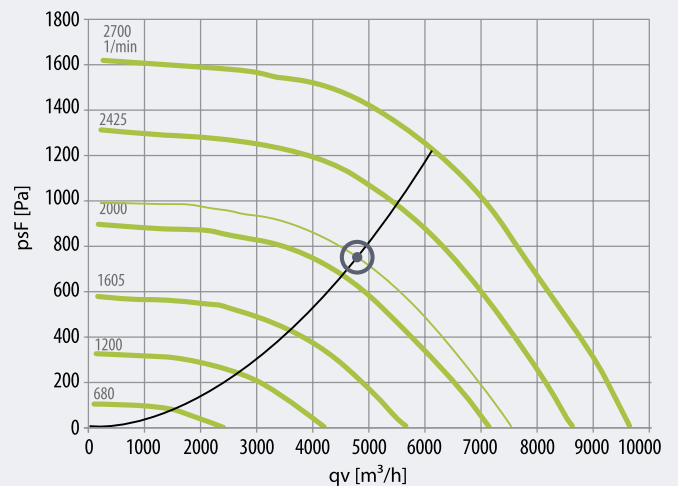

MANDÍK CPV48-H

Maximum external pressure CPV48 standard – inlet part

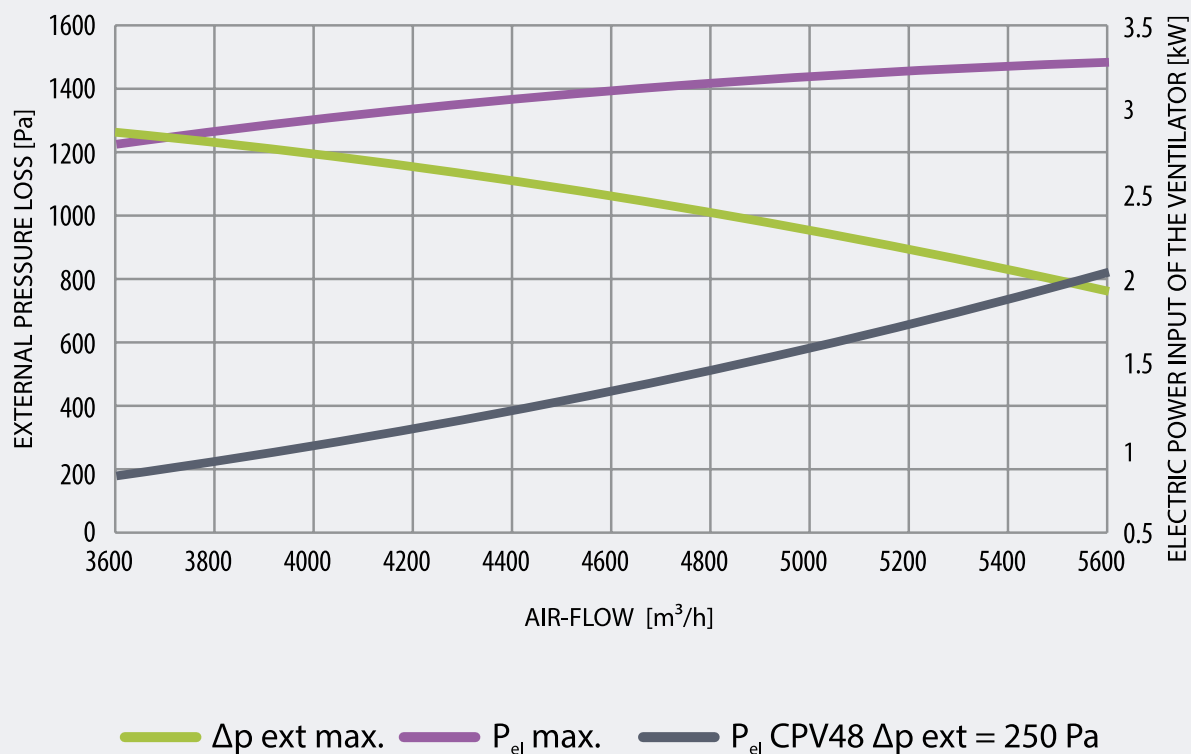

Efficiency of the heat exchanger ZZT

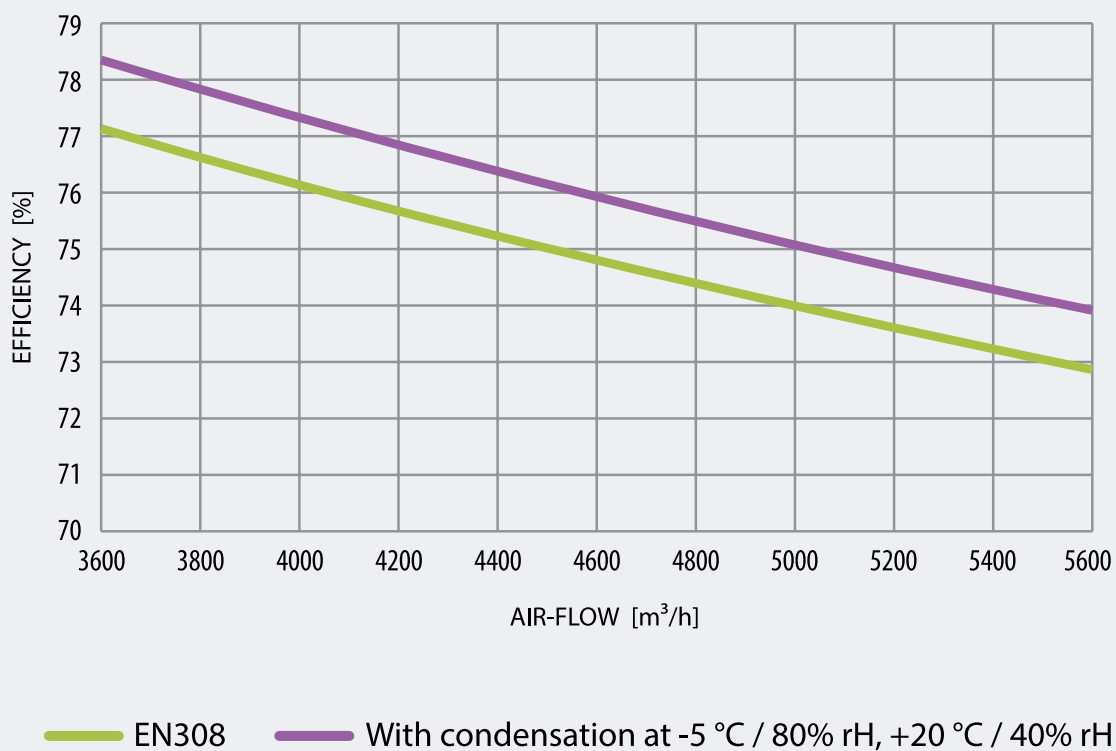

STANDARD EQUIPMENT

SURFACE TREATMENT:

- Outer surface and end element – powder paint
- Inner surface and in-building – powder paint

COMPONENTS:

- ZZT – counter-flow recuperation exchanger (aluminium)
- by-pass recuperation
- EC ventilators (free impellers) – inlet / outlet
- filtration – F7 inlet, M5 outlet
- lamella hot-water heater / electric heater / condenser
- suction flap of fresh air
- discharge flap of waste air
- by-pass flap
- mixing flap / circulation
- buffering inserts, square shape, 2x suction, 2x discharge
- base frame of the unit

CONTROL, ELECTRO EQUIPMENT:

- switchboard, in-built
- PLC, display (possible parametrization), web interface (possible parametrization)
- servo-drives of flaps – inlet / outlet / by-pass / mixing
- switching the pressure difference of filters – inlet / outlet
- temperature sensors – fresh / behind recuperation / inlet / outlet / recuperation frost
- capillary thermostat (anti-frost) of the hot-water heater
- control of performance of electric heat (PWM, SSR)
- service switch
- socket 230 V
- socket RJ45
- probes to measure pressure difference of the ventilator – inlet / outlet

ACCESSORIES

MIXING KNOTS:

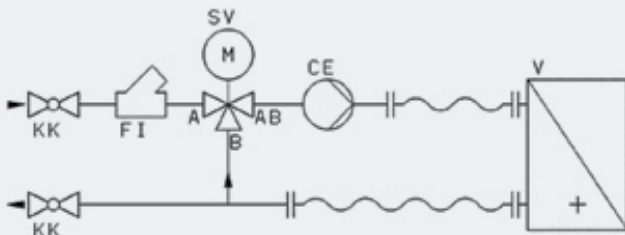

- KK – closing ball valve
- FI – filter
- SV – regulation ball valve with servo-drive
- CE – pump
- V – water exchanger

- Mixing knot of the hot-water heater CPV48, $Q_t = 24.8$ kW
 - Heat-bearing medium: water 80/60 °C USJR 25-60-2.5-SR Rp 3/4" Rp 3/4", 1.28 m³/h
 - Heat-bearing medium: water 70/50 °C USJR 25-60-2.5-SR Rp 3/4" Rp 3/4", 1.28 m³/h
 - Heat-bearing medium: water 50/40 °C USJR 25-60-6.3-SR Rp 1" Rp 1", 2.22 m³/h
 - Heat-bearing medium: water 45/35 °C USJR 25-60-6.3-SR Rp 1" Rp 1", 2.22 m³/h
- Mixing knot of the hot-water heater CPV48, $Q_t = 29.1$ kW
 - Heat-bearing medium: water 80/60 °C USJR 25-60-2.5-SR Rp 3/4" Rp 3/4", 1.28 m³/h
 - Heat-bearing medium: water 70/50 °C USJR 25-60-2.5-SR Rp 3/4" Rp 3/4", 1.28 m³/h
 - Heat-bearing medium: water 50/40 °C USJR 25-100-6.3-SR Rp 1" Rp 1", 3.38 m³/h
 - Heat-bearing medium: water 45/35 °C USJR 25-100-6.3-SR Rp 1" Rp 1", 3.38 m³/h
- Mixing knot of the hot-water heater CPV48, $Q_t = 33.9$ kW
 - Heat-bearing medium: water 80/60 °C USJR 25-60-4.0-SR Rp 3/4" Rp 3/4", 1.68 m³/h
 - Heat-bearing medium: water 70/50 °C USJR 25-60-4.0-SR Rp 3/4" Rp 3/4", 1.68 m³/h
 - Heat-bearing medium: water 50/40 °C USJR 25-100-6.3-SR Rp 1" Rp 1", 3.38 m³/h
 - Heat-bearing medium: water 45/35 °C USJR 25-100-6.3-SR Rp 1" Rp 1", 3.38 m³/h

MANDÍK CPV48-H

3-WAY VALVES

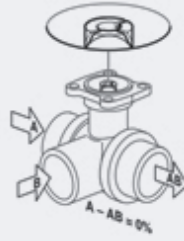
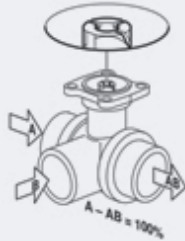

■ 3-way valve of the water heater CPV48, $Q_t = 24.8$ kW

Heat-bearing medium: water 80/60 °C

Heat-bearing medium: water 70/50 °C

Heat-bearing medium: water 50/40 °C

Heat-bearing medium: water 45/35 °C

BELIMO, R3015-1P6-S1, kvs = 1.6 m³/h, DN = 15.5 Nm

BELIMO, R3015-1P6-S1, kvs = 1.6 m³/h, DN = 15.5 Nm

BELIMO, R3015-2P5-S1, kvs = 2.5 m³/h, DN = 15.5 Nm

BELIMO, R3015-2P5-S1, kvs = 2.5 m³/h, DN = 15.5 Nm

■ 3-way valve of the water heater CPV48, $Q_t = 29.1$ kW

Heat-bearing medium: water 80/60 °C

Heat-bearing medium: water 70/50 °C

Heat-bearing medium: water 50/40 °C

Heat-bearing medium: water 45/35 °C

BELIMO, R3015-1P6-S1, kvs = 1.6 m³/h, DN = 15.5 Nm

BELIMO, R3015-1P6-S1, kvs = 1.6 m³/h, DN = 15.5 Nm

BELIMO, R3015-4P-S1, kvs = 4.0 m³/h, DN = 15.5 Nm

BELIMO, R3015-4P-S1, kvs = 4.0 m³/h, DN = 15.5 Nm

■ 3-way valve of the water heater CPV48, $Q_t = 33.9$ kW

Heat-bearing medium: water 80/60 °C

Heat-bearing medium: water 70/50 °C

Heat-bearing medium: water 50/40 °C

Heat-bearing medium: water 45/35 °C

BELIMO, R3015-2P5-S1, kvs = 2.5 m³/h, DN = 15.5 Nm

BELIMO, R3015-2P5-S1, kvs = 2.5 m³/h, DN = 15.5 Nm

BELIMO, R3015-4P-S1, kvs = 4.0 m³/h, DN = 15.5 Nm

BELIMO, R3015-4P-S1, kvs = 4.0 m³/h, DN = 15.5 Nm

SERVO DRIVES FOR 3-WAY VALVES

■ BELIMO LR24A-SR, AC/DC 24 V, 0–10 V, 5 Nm

CO₂ SENSOR

■ PROTRONIX AS CO2-DG, 0–10 V, 400–2000 ppm

REMOTE CONTROL

■ DIGICONTROL ROOM4D
Temperature adjustment, control of rotational speed of the ventilator, integrated temperature sensor, 2× DO (0 V / 24 V DC) CAN-Bus, DALI, KNX, Modbus

VISUALIZATION

■ License for visualization Webservice
Overall graphic view of the unit with the current condition of action elements and sensors of MaR system (measuring and regulation)

ROUTER

■ TP-LINK TL-WR841ND
WiFi router 802.11b/g/n až 300 Mbps, 1× WAN, 4× LAN

SIPHON FOR CONDENSATE OUTLET

■ HL136NGG, DN32, vacual with ball

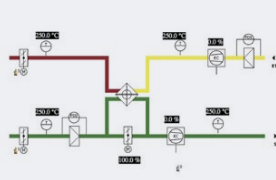
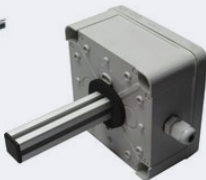

ORDER CODE FOR THE COMPACT UNITS OF CPV SERIES

Type of unit	Size of unit	Post heating	Cooling	Filtration	Equipment of flaps	Outlets
CPV	12	XXX	XXX	XXXX	XXX	XXX
1st sign C = compact 2nd sign P = board recuperation 3rd sign V = vertical	1st-, 2nd sign = * 100 = Vn [m ³ /h] 12 = 1200 m ³ /h 24 = 2400 m ³ /h 36 = 3600 m ³ /h 48 = 4800 m ³ /h 60 = 6000 m ³ /h	1st sign = type of post heat 1 = water heater 2 = condenser 3 = electric heater 2nd sign = medium 0 = no (electric heater) 1 = water 80/60 °C 2 = water 70/50 °C 3 = water 50/40 °C 4 = water 45/35 °C 5 = cooling agent R410A 6 = cooling agent R407C 3rd sign = heat power 1 = LOW (SUP = +22 °C) 2 = MEDIUM (SUP = +25 °C) 3 = HIGH (SUP = +28 °C)	XXX = none	1st sign = type of inlet filtration 3rd sign = type of outlet filtration 2 = M5 3 = F7 2nd sign = type of inlet filter 4th sign = type of outlet filter 1 = frame with thickness 96 mm	1st sign = mixing flap 0 = mixing flap not installed 1 = mixing flap installed* 2nd sign = inlet flap 0 = mixing flap not installed 1 = inlet flap installed* 3rd sign = outlet flap 0 = outlet flap not installed 1 = outlet flap installed*	1st sign = right* 2nd sign = location of SUP and EHA outlets 1 = top wall* 2 = lateral walls 3rd sign = type of outlets 1 = rectangular outlets*

CPV48-121-XXX-3121-111-111

4800 m³/h
 Water heater, medium 80/60 °C, heat performance LOW (24.8 kW)
 no
 inlet = F7 frame with thickness 96 mm, outlet: M5 frame with thickness 96 mm
 mixing: installed, inlet: installed, outlet: installed
 to the right -> right version
 on the top wall
 rectangular shape

Example of the unit:

Nominal air power:
 Post heating:
 Cooling:
 Filtration:
 Flaps:
 Flow direction SUP:
 Outlets SUP and EHA:
 Type of outlets:

Note:
 * standard version Paint:
 In case of requirement for a version other than standard, this should be noted in the purchase order.
 Painting is divided into 2 parts (as standard)
 1) RAL colour of the cabinet (outer) + inner + in-building: RAL9010 (standard version)
 2) RAL colour of the central panel + buffering inserts + base frame RAL9006 (standard version)
 Optionally, the parts of the unit may be combined in various ways; such as the overall outer surface (sheathing, buffering inserts, base frame) in one colour; inner surface (sheathing, in-building) in another colour, etc.

MANDÍK, a. s.

Dobříšská 550

267 24 HOSTOMICE

Czech Republic

Phone: +420 311 706 706

Fax: +420 311 584 810

E-mail: mandik@mandik.cz

www.mandik.cz